

This article was downloaded by:

On: 24 January 2011

Access details: *Access Details: Free Access*

Publisher *Taylor & Francis*

Informa Ltd Registered in England and Wales Registered Number: 1072954 Registered office: Mortimer House, 37-41 Mortimer Street, London W1T 3JH, UK



## Journal of Macromolecular Science, Part A

Publication details, including instructions for authors and subscription information:

<http://www.informaworld.com/smpp/title~content=t713597274>

### APPLICATION OF ALKYLATED CROWN ETHER DERIVATIVE IN MODIFYING SELECTIVITY OF POLYPROPYLENE MEMBRANES

Monika Naumowicz<sup>a</sup>; Anna Wencel<sup>a</sup>; Zbigniew Figaszewski<sup>ab</sup>

<sup>a</sup> Institute of Chemistry, University in Białystok, Białystok, Poland <sup>b</sup> On leave from the Chemistry Department, University of Warsaw, Warsaw, Poland

Online publication date: 28 February 2001

**To cite this Article** Naumowicz, Monika , Wencel, Anna and Figaszewski, Zbigniew(2001) 'APPLICATION OF ALKYLATED CROWN ETHER DERIVATIVE IN MODIFYING SELECTIVITY OF POLYPROPYLENE MEMBRANES', *Journal of Macromolecular Science, Part A*, 38: 3, 291 – 306

**To link to this Article:** DOI: 10.1081/MA-100103350

**URL:** <http://dx.doi.org/10.1081/MA-100103350>

## PLEASE SCROLL DOWN FOR ARTICLE

Full terms and conditions of use: <http://www.informaworld.com/terms-and-conditions-of-access.pdf>

This article may be used for research, teaching and private study purposes. Any substantial or systematic reproduction, re-distribution, re-selling, loan or sub-licensing, systematic supply or distribution in any form to anyone is expressly forbidden.

The publisher does not give any warranty express or implied or make any representation that the contents will be complete or accurate or up to date. The accuracy of any instructions, formulae and drug doses should be independently verified with primary sources. The publisher shall not be liable for any loss, actions, claims, proceedings, demand or costs or damages whatsoever or howsoever caused arising directly or indirectly in connection with or arising out of the use of this material.

## APPLICATION OF ALKYLATED CROWN ETHER DERIVATIVE IN MODIFYING SELECTIVITY OF POLYPROPYLENE MEMBRANES

Monika Naumowicz, Anna Wencel, and Zbigniew Figaszewski\*

Institute of Chemistry, University in Białystok, Al. J. Piłsudskiego 11/4,  
15-443 Białystok, Poland

### ABSTRACT

It has been investigated whether it is possible to induce selectivity to polymer membranes by modifying them with an alkylated crown ether derivative. Polypropylene (PP) membranes were hydrophilized with 2-hydroxymethyl [18]corona-6 palmitate solutions of concentrations ranging from 0 to 60 wt% in a 1,2-dichloroethane-hexane solvent system of 1:4 volume ratio. The investigations were carried out by an impedance measurement method using two electrolyte solutions:  $0.1 \text{ mol-dm}^{-3}$  NaCl and  $0.1 \text{ mol-dm}^{-3}$  KCl. Changes in transport properties of the studied membranes were evaluated as a function of hydrophilizing agent concentrations. Electric resistance of the studied membranes was found to decrease drastically in the 0–5 wt% 2-hydroxymethyl [18]corona-6 palmitate concentration range, and it proved to be constant at higher concentrations. Non-Debye capacitance of the membranes increased in the 0–5% concentration range, and was constant at higher concentrations. Polypropylene membranes hydrophilized with 2-hydroxymethyl[18]corona-6 palmitate were found to behave differently depending on the electrolyte used. This suggests that macrocyclic groups are able to induce selectivity to polypropylene membranes.

*Key Words:* Impedance; Polypropylene membranes; Hydrophilization; Selectivity; 2-Hydroxymethyl[18]corona-6 palmitate.

---

\*Corresponding author. On leave from the Chemistry Department, University of Warsaw, ul. Pasteura 1, 02-093 Warsaw, Poland.

## INTRODUCTION

Selectivity and transport rate of components are fundamental properties of the membranes from the point of view of their application. Wettability, porosity, and pore distribution play an important role in the transport of mass through a membrane (1, 2).

Polypropylene membranes were used in this work to build ion-selective membranes. They have been used hitherto for separation of numerous ions; their importance and the number of applications have been increasing.

Polypropylene membranes are one of the main types of membranes used for separating ions. The significance of these membranes and the degree of their application increases rapidly (3–7). To construct ion-selective membrane on a specific ion, a neutral or charged lipophilic compound is used. The compound is able to bind the ion reversibly and transport them through the membrane on the way of translocation (8, 9). So far, numerous ionophores have already been synthesized. They are selective either to alkali metal ions, ions of transition group metal, heavy metal ions (10–14), organic cations (crown ethers (15–17), hemispherands (18), calixarenes (19, 20)) or to anions (macrocyclic polyammonium compounds (21), guanidine derivatives (22, 23), receptors with metal atoms (e.g., salophenes) (24, 25).

Since their development in 1976 (26), crown ether molecules have been exploited as the ionophore for the specific complexation they provide with alkali metal ions. The work of Fyles and coworkers (27–29) concerning the synthesis of ion channels and their properties deserve special attention. During the research, the scientists discovered the existence of a transport selectivity series ( $K^+ > Rb^+ > Cs^+ > Na^+ > Li^+$ ) corresponding to the properties of the crown ether used. They have found that the activation energy equals 30 kJ/mol, which is comparable to the activation energy of ions transport by gramicidin (32 kJ/mol). Interesting results have been obtained in the case of membranes containing crown ethers (with carboxylic groups) immobilized within pores of polyamide membranes (30); as well as membranes obtained from polymers containing crown rings in the main chain (31). The results of the experiments conducted on similar polymer membranes are promising if we take into consideration the fact that channel mechanism enables quick transportation of ions according to their size. The physicochemical characteristics of this process is already well-known (15, 32, 33).

Hydrophobic polypropylene membranes, which do not contain water solution in their pores, are characterized by high electric resistance. Hydrophilic membranes containing electrolyte water solution in their pores are characterized by low electric resistance (34). The contribution of particular ions influence the conductivity of such membrane. Membranes selective for specific ions are characterized by low conductivity in the presence of those ions. The contribution of particular ions in conductivity is generally described by means of electric equivalence circuits with transport shown as connected parallel branches (35).

The aim of this work is to check if the introduction of a group selectively binding a given ion or a group of ions into membrane pores fulfills the role of ionophores and induces selectivity to these ions to the membrane. A compound that selectively complexes a given ion is needed to design an ion-selective membrane. Synthesizing an alkylated crown ether derivative aims at obtaining a compound that should combine selectivity with a relatively long alkyl chain. The compound should undergo adsorption at the hydrophobic membrane surface due to its hydrophobic part (the alkyl chain) and to form a complex with metal ion from aqueous solution flowing through the membrane due to its hydrophilic part (the macrocyclic ring).

Transport properties of polypropylene membranes subject to hydrophilization with a crown ether derivative, were determined by studying the permeability of the  $\text{Na}^+$ ,  $\text{K}^+$ , and  $\text{Cl}^-$  ions through the modified membrane (by means of impedance).

The impedance measurement method was used in the studies because of its accuracy, rapidity (in a computer controlled system), and effectiveness in electrochemical studies (36–38). Although today, impedance spectroscopy is a standard electrochemical method, the treatment of a porous membrane with surface charge, i.e., with some ion selectivity, has rarely been described in the literature (39–42).

## EXPERIMENTAL

### Synthesis of 2-Hydroxymethyl[18]corona-6 Palmitate

2-Hydroxymethyl[18]corona-6 ether was dissolved in a double amount of palmitoyl chloride and tetradimethylaminopyridine was added as catalyst. Pyridine was added to the mixture to form salt with evolving hydrogen chloride and to prevent acidifying the solution. The mixture was stirred for 24 h, then poured into cold water (283 K), and extracted three times with diethyl ether. The extract was washed with hydrochloric acid and water to remove pyridine and with aqueous sodium hydrogen carbonate to remove the excess of palmitoyl chloride and palmitic acid formed by palmitoyl chloride hydrolysis.

The organic phase was dried with anhydrous magnesium(II) sulphate(VI). A brown-yellow oil, obtained after evaporation of the solvent, was purified by column chromatography using chloroform an increasing content of methanol (up to 10%) as eluent.

The presence of 2-hydroxymethyl[18]corona-6 palmitate was confirmed by proton nuclear magnetic resonance ( $^1\text{H}$  NMR),  $^{13}\text{C}$  NMR, and infrared (IR) spectra.

### Hydrophilization of Membranes

Standard 2E-PP membranes with 0.2 to 0.58- $\mu\text{m}$  pores manufactured by ACCUREL were used. Their physical properties were described in (43). The syn-

thesized 2-hydroxymethyl[18]corona-6 palmitate was used as a hydrophilizing agent. The hydrophilization of a membrane was carried out by immersing it in a boiling 2-hydroxymethyl[18]corona-6 palmitate solution of suitable concentration for 1 h. The ester was dissolved in 1,2-dichloroethane-hexane mixture of 1:4 volume ratio (1,2-dichloroethane increases solubility of the ester and hexane prevents hydrophilization of the membrane with 1,2-dichloroethane). The hydrophilization was monitored by measuring the membrane impedance and it was being continued until the results proved reproducible.

### Impedance Measurement

The Model 273A set manufactured by PAR was used in the measurements. The block diagram of the apparatus was presented in (44) and the measuring vessel was described in (45). The measurements were made in the 5 Hz-2.5 kHz frequency range using a four-electrode arrangement with two platinum current electrodes and two silver-silver chloride measuring electrodes. The measurements were carried out in  $0.1 \text{ mol}\cdot\text{dm}^{-3}$  NaCl electrolyte and then the membrane was placed in  $0.1 \text{ mol}\cdot\text{dm}^{-3}$  KCl for 24 h. The duration was sufficient to achieve complete replacement of sodium ion in the complexation centers by potassium ion because crown ethers with 18 atoms in the ring form more stable complexes with the  $\text{K}^+$  ion than with the  $\text{Na}^+$  ions (46)). The measurements were then carried out in the  $0.1 \text{ mol}\cdot\text{dm}^{-3}$  KCl electrolyte.

The properties of membranes are successfully described in terms of the Randles's model (36). However, the experimental impedance spectra of real samples differ from those of ideal (Debye) capacitors and resistors. The half-circle centers in the spectra of membranes were situated below the  $Z'$  axis and they were characterized as a resistor,  $R$ , and a non-Debye capacitor,  $Q$ , of constant phase angle also called CPE (Constant Phase Element). The parameters characterizing the membrane were calculated from such a spectrum using the Equivalent Circuit program (Equivcrt.Pas) elaborated by B. A. Boukamp (47).

Two electric equivalent circuits were used to describe the properties of membranes (Fig. 1). In the case where  $0.1 \text{ mol}\cdot\text{dm}^{-3}$  NaCl electrolyte was used, the sodium ions were complexed by 2-hydroxymethyl[18]corona-6 palmitate present at the surface hereby introducing the surface conductivity (the surface transport) of complexed sodium ions. It brought about the appearance of the  $(\Theta_2, Q_2)$  branch (Fig. 1) in the equivalent circuit. In the case of the  $0.1 \text{ mol}\cdot\text{dm}^{-3}$  KCl electrolyte, the potassium ions were very strongly complexed and did not contribute to surface transport; it resulted in the reduction of Model I (Fig. 1a) to Model II presented in Figure 1b.

## RESULTS AND DISCUSSION

Typical plots of impedance of chosen membranes, hydrophobic and hydrophilized ones, are presented in Figures 2–4. The dependence of the changes

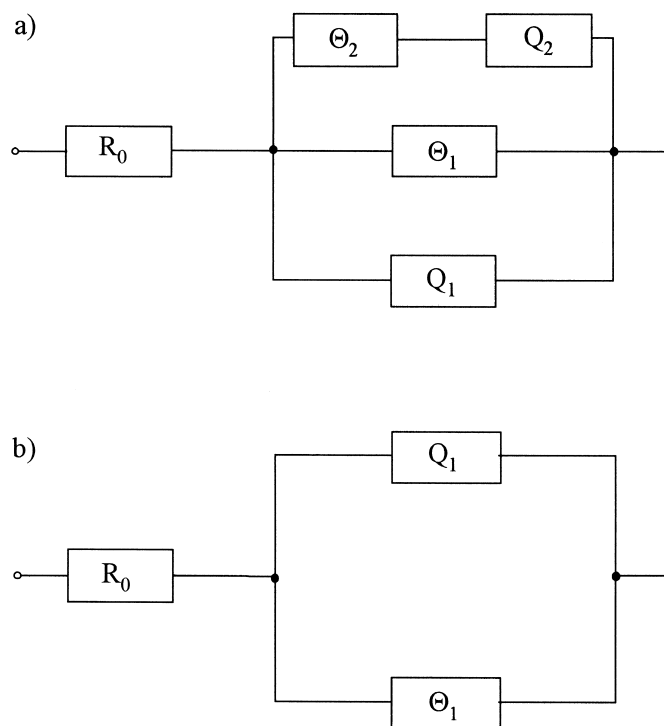

**Figure 1.** Electric equivalent circuit of experimental impedance: a) 0.1 mol·dm<sup>-3</sup> NaCl electrolyte (Model I); b) 0.1 mol·dm<sup>-3</sup> KCl electrolyte (Model II). Here,  $R_0$  - electrolyte resistance,  $Q_1$  - non-Debye capacitance due to pore filling with electrolyte,  $\Theta_1$  - electrolyte resistance in pores, and  $\Theta_2$ ,  $Q_2$  - surface transport due to sodium ion complexes.

of characteristic parameters of hydrophilized membranes: resistance ( $\Theta$ ) and non-Debye capacitance ( $Q$ ) on hydrophilizing agent concentration are presented in Figures 5 and 6. Mean experimental values are collected in Table 1.

Hydrophilization of polypropylene membranes is schematically presented in Figure 7.

In the presence of 0.1 mol·dm<sup>-3</sup> NaCl electrolyte, the Cl<sup>-</sup> and Na<sup>+</sup> ions traverse through the membrane. In Figure 3, the first half-circle corresponds to the volume transport of these ions through the membrane, while the second one is responsible for the surface transport of the Na<sup>+</sup> ions, which is due to the weak complexing by 2-hydroxymethyl[18]corona-6 palmitate present on the surface of pores. Stability constant of the formed complex is so low that the cations are liberated from the macrocyclic crown and transported in the layer of the complex on the surface of pores.

One half-circle appears only in the case of 0.1 mol·dm<sup>-3</sup> KCl electrolyte (Fig. 4). The potassium ions are stopped by the polyether crown while the chloride

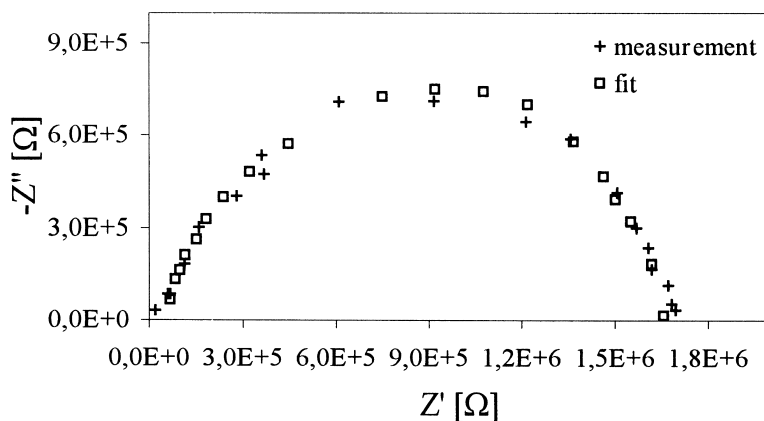

**Figure 2.** Dependence of the imaginary part ( $Z''$ ) on the real part ( $Z'$ ) for a hydrophobic membrane (+ - experimental points, - nonlinear fit of the impedance function (16)).

ions traverse through the membrane. The hydrophilized membrane is positively charged and, therefore, reduces permeability for potassium ions. 2-Hydroxymethyl[18]corona-6 palmitate molecule diameter is smaller than the pore diameter of the polypropylene membrane. For this reason, not all  $K^+$  ions are complexed; a part of them pass through the center of the pore. Therefore, it may be concluded that the created half-circle is influenced by the chloride ions and a part of the potassium ions that are not complexed.

As seen in Figure 5, the membrane resistance drastically decreases in the 0–5 wt% 2-hydroxymethyl[18]corona-6 palmitate concentration range and becomes constant above 5 wt%. These changes suggest that the adsorption of ester molecules at the membrane surface and in the pores gradually increases in the 0–5

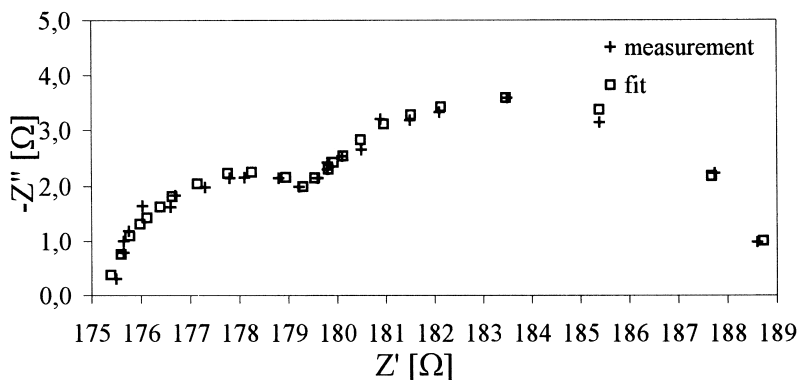

**Figure 3.** Dependence of the imaginary part ( $Z''$ ) on the real part ( $Z'$ ) for a membrane hydrophilized with 8 wt% 2-hydroxymethyl[18]corona-6 palmitate using  $0.1 \text{ mol}\cdot\text{dm}^{-3}$  NaCl electrolyte.

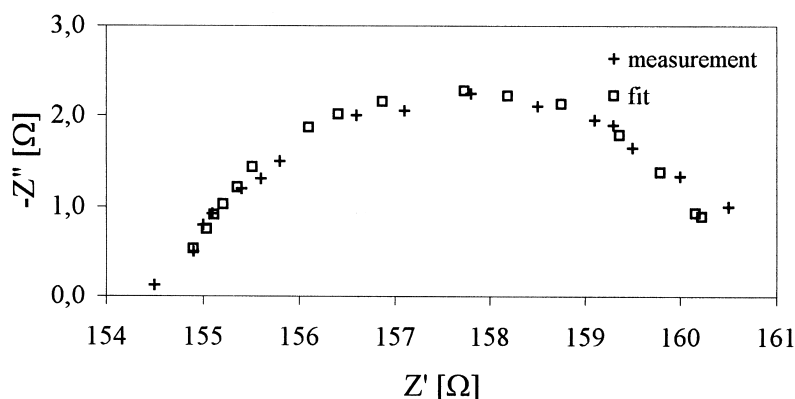

**Figure 4.** Dependence of the imaginary part ( $Z''$ ) on the real part ( $Z'$ ) for a membrane hydrophilized with 8 wt% 2-hydroxymethyl[18]corona-6 palmitate using  $0.1 \text{ mol}\cdot\text{dm}^{-3}$  KCl electrolyte.

wt% concentration range. A constant  $\Theta$  value in concentrations above 5 wt% indicates that the ester molecules are not further adsorbed. Thus, it can be assumed that with 5 wt%, the ester adsorption and membrane hydrophilization reach maximal value.

The non-Debye capacitance of the membranes (Fig. 6) increases in the 0–5 wt% 2-hydroxymethyl[18]corona-6 palmitate concentration range and does not change when the concentration is further increased.

The capacitance of condenser reflects the ability to store electric energy. When there are dipoles inside the condenser, capacity drastically increases. The storage of energy is then related to the orientation of dipoles by electric field. The presence of electric charges in ion-selective functional groups, which are connected to the membrane by long chains, enables the deflection of chains due to the field. As a result, the condenser capacity increases and the storage of electric energy is possible. All the above described occurrences cause a high increase of non-Debye capacitance of polymeric membranes modified by 2-hydroxymethyl [18]corona-6 palmitate.

**Table 1.** Mean Calculated  $\Theta$  and Q Parameters After Stabilization

0.1 mol·dm <sup>-3</sup> NaCl				0.1 mol·dm <sup>-3</sup> KCl	
$\Theta_1$ [Ω]	$\Theta_2$ [Ω]	$Q_1$ [F]	$Q_2$ [F]	$\Theta$ [Ω]	Q [F]
5.79	11.60	$4.50\cdot 10^{-3}$	$6.16\cdot 10^{-3}$	6.16	$1.42\cdot 10^{-3}$

Hydrophilization of polypropylene membranes is schematically presented in Fig. 7.



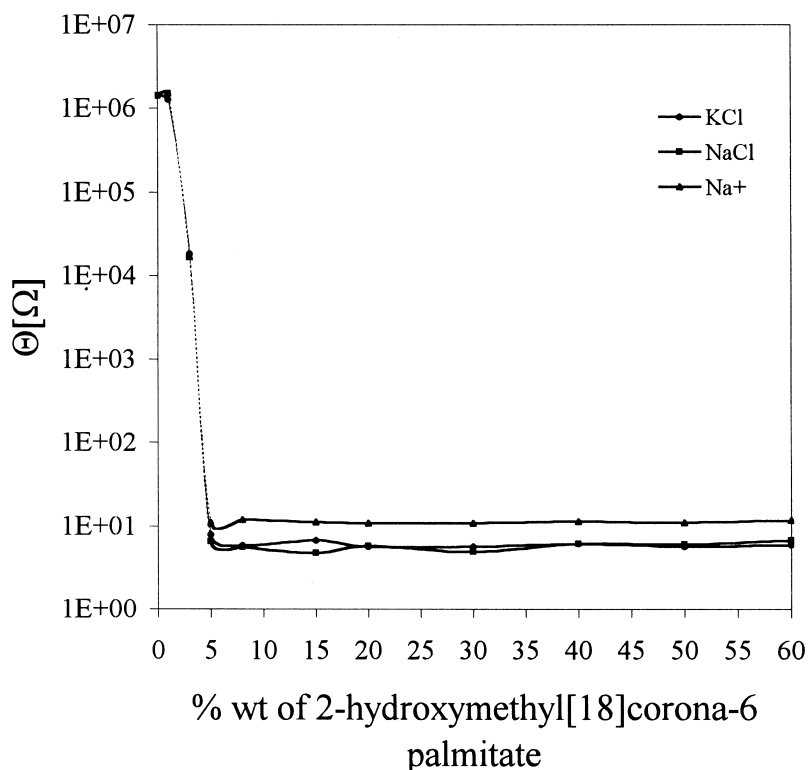

**Figure 5.** Variation of membrane resistance ( $\Theta$ ) with 2-hydroxymethyl[18]corona-6 palmitate concentration.

The increase in non-Debye capacitance of membrane, accompanied by the decrease in resistance (Figs. 5 and 6) in the 0–5 wt% range. It suggests that the pores are only partly hydrophilized. It can be assumed that the decrease in resistance is caused by the transport of ions through completely hydrophilized pores. Whereas, partly hydrophilized pores filled with electrolyte contribute to the increase in non-Debye capacitance only.

Constant  $\Theta$  and  $Q$  values above 5 wt% 2-hydroxymethyl[18]corona-6 palmitate concentration are evidence that the membranes are completely hydrophilized in this range. Consequently, the transport of ions is stable there.

An analysis of variations in experimental parameters allows us to state that the hydrophilization process of polypropylene membranes is complete at about 5 wt% of the ester. The hydrophilization of membrane is not affected by a further increase in hydrophilizing agent concentration.

The resistance of hydrophilized membranes can be described in terms of conductance:

$$\frac{1}{\Theta} = \frac{\lambda_- \cdot c_- \cdot S_-}{l} + \frac{\lambda_+ \cdot c_+ \cdot S_+}{l} \quad (1)$$

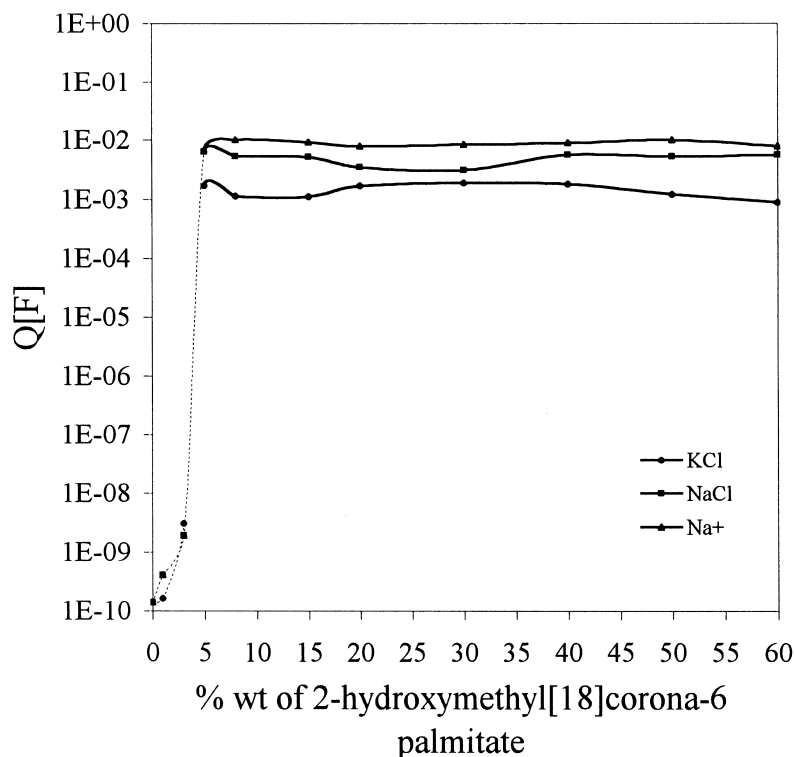

**Figure 6.** Variation of non-Debye capacitance (Q) with 2-hydroxymethyl[18]corona-6 palmitate concentration.

Here:

$\lambda_+$ ,  $\lambda_-$ , - molar conductivity of ions,

$\lambda_{\text{Na}^+} = 50.6 \cdot 10^{-4}$ ,  $\lambda_{\text{K}^+} = 73.5 \cdot 10^{-4}$ ,  $\lambda_{\text{Cl}^-} = 76.5 \cdot 10^{-4} \text{ m}^2 \cdot \Omega^{-1} \cdot \text{mol}^{-1}$  [48],

$c$  - electrolyte concentration,  $0.1 \text{ mol} \cdot \text{dm}^{-3}$ ,

$S$  - membrane area,  $31.17 \cdot 10^{-6} \text{ m}^2$ ,

$\tau$  - membrane thickness,  $100 \cdot 10^{-6} \text{ m}$ .

Because the anion and cation concentrations are equal and identical with the electrolyte concentration, i.e.,  $c_+ = c_- = c$ , the above equation takes the form:

$$\frac{1}{\Theta} = \frac{c}{\tau} \cdot (\lambda_- \cdot S_- + \lambda_+ \cdot S_+) \quad (2)$$

and it can be transformed into:

$$\Theta = \frac{\tau}{c \cdot (\lambda_- \cdot S_- + \lambda_+ \cdot S_+)} \quad (3)$$

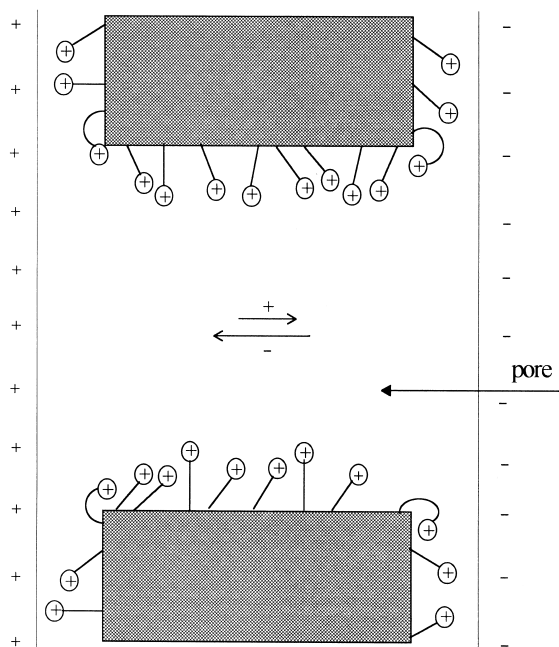

**Figure 7.** Scheme of polypropylene membrane hydrophilization with 2-hydroxymethyl[18]corona-6 palmitate. Dependence of the imaginary part ( $Z''$ ) on the real part ( $Z'$ ) for a membrane hydrophilized with 8 wt% 2-hydroxymethyl[18]corona-6 palmitate using  $0.1 \text{ mol}\cdot\text{dm}^{-3}$  NaCl electrolyte.

The pore surface area of the membrane, which is accessible for the transport of cations ( $S_+$ ), can be assumed to be equal to that of the anions ( $S_-$ ):

$$S_+ = S_- = \alpha \cdot S \quad (\alpha - \text{filling coefficient pore in membrane}) \quad (4)$$

Therefore, the electrolyte resistance can be presented as:

$$\Theta = \frac{l}{c \cdot S \cdot \alpha (\lambda_- + \lambda_+)} \quad (5)$$

The assumption (4) an approximation because hydrophilized membrane is positively charged.

The experimental capacitance values are presented in Table 1. The experimental capacitance is the sum of polymer part capacitance given by the first term of Equation 6, capacitance of pores filled with electrolyte solution given by the second term and  $C_c$ , complexing agent capacitance:

$$C = \frac{S \cdot (1 - \alpha) \cdot \epsilon_p \cdot \epsilon_o}{l} + \frac{S \cdot \alpha \cdot \epsilon_w \cdot \epsilon_o}{l} + C_c \quad (6)$$

Here:

S - membrane surface area,

$\epsilon_p$  - relative electric permittivity of hydrophobic polypropylene membrane, 3.80,

$\epsilon_w$  - relative permittivity of vacuum,  $8.85 \cdot 10^{-12}$  F/m,

l - membrane thickness.

$C_c$  can be presented as the sum:

$$C_c = C_{c_{\text{pore}}} + C_{c_{\text{surface}}} \quad (7)$$

where:

$C_{c_{\text{pore}}}$  - capacitance due to the complexing factor present at the pore surface,

$$C_{c_{\text{surface}}} = S \cdot (1 - \alpha) \cdot c_{\text{surface ester}} \cdot K \quad (8)$$

$c_{\text{surface ester}}$  - surface concentration of the hydrophilizing agent,

K - coefficient responsible for storing electric energy by hydrocarbon chain having the freedom of motion,

$C_{c_{\text{surface}}}$  - capacitance caused by the presence of complexing factor at the membrane surface

$$C_{c_{\text{pore}}} = \frac{S \cdot c_{\text{surface ester}} \cdot K}{l} \quad (9)$$

where s is pore length.

Estimation of two initial terms of Equation 6 assuming suitable values yields  $1.05 \cdot 10^{-11}$  F and  $2.21 \cdot 10^{-10}$  F, respectively. The comparison of these values with the values obtained from the measurement of capacitance (Tab. 1) shows that the measured capacitance should be linked to the third element describing the presence of complexing agent (2-hydroxymethyl[18]corona-6 palmitate).

Relative electric permittivity of hydrophilic membranes, which equals  $1.46 \cdot 10^9$ , has been calculated on the basis of results obtained in the measurements of non-Debye capacitance. The increase of permittivity in hydrophilic membranes in comparison to hydrophobic ones (relative electric permittivity = 3.8) is surprising. However, similar permittivity values have been obtained by the authors (44). They used impedance measurement methods to analyze the changes in permeability of ions through polypropylene membranes in the function of ethyl alcohol concentration used for their hydrophilization. The increased permittivity is related to the deflection of long chains of hydrophilizing agents. In the work (41), similar

permittivity values have been obtained when ion-exchanging membranes as the temperature function have been analyzed, by means of the impedance method. According to the quoted authors, the increasing mobility of ion-exchanging groups in the membranes the increase of temperature causes the increase of relative electric permittivity. It suggests that hydrophilization of membranes gives similar effects of permittivity as the temperature increases.

It can be summarized that the analysis of the changes in experimental  $\Theta$  and  $Q$  parameters at the complexing agent concentrations above 5 wt% proves that building-in of groups selectively binding a given ion or a given group of ions into the pores of polymer matrix induces selectivity of the membrane to these ions.

The impedance method has only been used by few authors to study polymeric membranes containing crown ethers (30, 31, 49–52). Analog studies concerning polypropylene membranes have not been carried out so far.

In the continuation of the studies of polypropylene modification, it seems appropriate to undertake the synthesis of derivatives of ether with 15 atoms in the main ring. Such compounds would form the most stable complexes with sodium cations. The ability of the membrane to retain sodium cations would be evident in the disappearance of one of the two half-circles in the analysed spectrum.

## CONCLUSION

A crown ether alkyl derivative, 2-hydroxymethyl[18]corona-6 palmitate, has been synthesized in this work, and its effect on the variation in hydrophobic character of polypropylene membranes has been analyzed. The ability of the synthesized ester to modify selectivity of membranes, as well as the effect of hydrophilization on transport properties of the membranes, have been considered. The impedance measurement method has been applied in the studies of hydrophobic polypropylene membranes. Two electrolytes:  $0.1 \text{ mol}\cdot\text{dm}^{-3}$  NaCl and  $0.1 \text{ mol}\cdot\text{dm}^{-3}$  KCl have been used in the impedance measurements.

Changes in transport properties of the studied membranes in the function of hydrophilizing agent concentration have been evaluated on the grounds of resistance and non-Debye capacitance results. Hydrophilization of hydrophobic polypropylene membranes with 2-hydroxymethyl[18]corona-6 palmitate have been found to be complete at 5 wt% concentration.

The polypropylene membranes hydrophilized with 2-hydroxymethyl[18]corona-6 palmitate behave differently depending on the used electrolyte, what suggests that macrocyclic groups are able to induce selectivity to polypropylene membranes.

On the basis of the changes in electric resistance ( $\Theta$ ) and in non-Debye capacitance ( $Q$ ) of the membranes in the function of 2-hydroxymethyl[18]corona-6 palmitate concentration the process of hydrophilization at the ester concentration of about 5 wt% has been found to be one-step. The transport properties of

polypropylene membranes become constant after hydrophilization with 2-hydroxymethyl[18]corona-6 palmitate.

The experimental impedance spectra and parameters representing the hydrophilization process indicate that the modified membranes behaved differently depending on the electrolyte used. It is caused by different mobility of ions traversing the polymer matrix and differences in the stability constants of ions complexes with 2-hydroxymethyl[18]corona-6 palmitate. The stability constant is considerably higher for the  $K^+$  ions than for the  $Na^+$  ions.

The continuation of the studies of modified polymer membranes should comprise the attempts to synthesize crown ether derivatives with 15 atoms in the main ring.

## REFERENCES

1. Timasher, S.F. Physicochemical Aspects of Ionic and Molecular Transport in Synthetic Membranes. In *Physical Chemistry of Membrane Processes*, 1st Ed.; Kemp, T.J., Ed.; Ellis Horwood: Chichester, England, 1991; 84–144.
2. Kesting, R.E. Characterization. In *Synthetic Polymeric Membranes*, 1st Ed.; Blau, G., Leaden, T.F., Oechsner, G.E., Eds.; McGraw-Hill Book Company: New York, 1971; 12–54.
3. Kesting, R.E. Applications. In *Synthetic Polymeric Membranes*, 1st Ed.; Blau, G., Leaden, T.F., Oechsner, G.E., Eds.; McGraw-Hill Book Company: New York, 1971; 271–299.
4. Bodzek, M.; Konieczny, K. Comparison of Various Membrane Types and Module Configurations in the Treatment of Natural Water by Means of Low-Pressure Membrane Methods. *Sep. Purif. Technol.* **1998**, *14* (1–3), 69–78.
5. Bamford, C.H.; Al-Lamee, K.G. Studies in Polymer Surface Modification and Grafting for Biomedical Uses: 2. Application to Arterial Blood Filters and Oxygenators. *Polymer* **1996**, *37* (22), 4885–4889.
6. Gryta, M.; Karakulski, K. The Application of Membrane Distillation for the Concentration of Oil-water Emulsions. *Desalination* **1999**, *121* (1), 23–29.
7. Campbell, R.A.; Bowry, K.; Fischer, A.C.; Gaylor, J.D.S. A Novel Automated Method for the Determination of Membrane Permeability in Gas-Liquid Transfer Applications. *J. Membr. Sci.* **1996**, *121* (2), 169–174.
8. Verbrugge, M.W.; Pintauro, P.N. Transport Models for Ion-exchange Membranes. In *Modern Aspects of Electrochemistry*, 1st Ed.; Conway, B.E., Bockris, J., White R.E., Eds.; Plenum Press: New York, 1989; 1–65.
9. Wróblewski, W.; Dybko, A.; Brzózka, Z. Projektowanie Jonoselektywnych Membran. In *Membrany i Procesy Membranowe w Ochronie Środowiska*, II Ogólnopolska Konferencja Naukowa, Ustron-Jaszowiec, Polska, Oct 23–25, 1997; Politechnika Śląska, Ed.; Profil-Druk: Gliwice, 1997; 193–200.
10. Zolotov, Y.A., Ed. *Macroyclic Compounds in Analytical Chemistry*, 1st Ed.; John Wiley & Sons: New York, 1997; 448.

11. Zhang, X.X.; Izatt, R.M.; Krakowiak, K.E.; Bradshaw, J.S. A Thermodynamic Study of Complexation of Alkali and Alkaline-Earth Metal Ions with Low-symmetry Cryptands. *Inorg. Chim. Acta.* **1997**, *254* (1), 43–47.
12. Qin, Y.; Yanming, M.; Bakker, E. Determination of Complex Formation of 18 Neutral Alkali and Alkaline Earth Metal Ionophores in Poly(vinyl chloride) Sensing Membranes Plasticized with Bis(2-ethylhexyl)sebacate and *o*-Nitrophenyl-octyl ether. *Anal. Chim. Acta.* **2000**, *421* (2), 207–220.
13. Elshani, S.; Kobzar, E.; Bartsch, R.A. Macrocyclic Ligands with Partially Fluorinated Sidearms: Synthesis and Metal Ion Complexation. *Tetrahedron* **2000**, *56* (21), 3291–3301.
14. Hilgenfeld, R.; Saenger, W. Structural Chemistry of Natural and Synthetic Ionophores and Their Complexes with Cations. In *Host Guest Complex Chemistry II*, 1st Ed.; Akademie-Verlag: Berlin, 1982, 1–82.
15. Yu, L.; Bao-Hang, H.; Yun-Ti, C. The Complexation Thermodynamics of Light Lanthanides by Crown Ethers. *Coord. Chem. Rev.* **2000**, *200–202*, 53–73.
16. Oehrle, S.A. Controlled Changes in Selectivity of Cation Separations by Capillary Electrophoresis Using Various Crown-ether Additives. *J. Chromatogr. A* **1996**, *745* (1–2), 87–92.
17. Pedersen, C.J. Macrocyclic Polyethers for Complexing Metals. *Aldrichim. Acta* **1971**, *4* (1), 1–4.
18. Hay, B.P.; Linrong, Y.; Delong, Z.; Rustad, J.R.; Wasserman, E. An Extended Molecular Mechanics (MM3(96)) Force Field for Benzocrown Ethers, Calixarenes and Spherands. *J. Mol. Struct. Theochem.* **1997**, *217* (1–2), 19–34.
19. Kim, J.S.; Cho, M.H.; Yu, I.Y.; Pang, J.H.; Kim, E.T.; Suh, I.H.; Oh, M.R.; Ra, D.Y.; Cho, N.S. Calix[4]arene Dibenzocrown Ethers as Cesium Ionophore. *Bull. Korean Chem. Soc.* **1997**, *18* (6), 677–680.
20. Arnaud-Neu, F.; Schwing-Weill, M.J. Calixarenes, New Selective Receptors. *Synthet. Metal.* **1997**, *90* (3), 157–164.
21. Pina, F.; Parola, A.J. Photochemistry of Supramolecular Species Involving Anionic Coordination Compounds and Polyammonium Macrocyclic Receptors. *Coord. Chem. Rev.* **1999**, *185–186*, 149–165.
22. Aiglstorfer, I.; Uffrecht, A.; Gessele, K.; Moser, C.; Schuster, A.; Merz, S.; Malawska, B.; Bernhardt, G.; Dove, S.; Buschauer, A. NPY Y<sub>1</sub> Antagonists: Structure-Activity Relationships of Arginine Derivatives and Hybrid Compounds with Arpromidine-like Partial Structures. *Regul. Pept.* **1998**, *75–76*, 9–21.
23. Zlotoidsky, P.; Mailiar, T. Synthesis and Structure-Activity Relationship Study of the New of Trypsin-like Proteinase Inhibitors. *Eur. J. Med. Chem.* **1999**, *34* (12), 1023–1034.
24. Snowden, T.S.; Anslyn, E.V. Anion Recognition: Synthetic Receptors for Anions and Their Application in Sensors. *Curr. Opin. Chem. Biol.* **1999**, *3* (6), 740–746.
25. Wróblewski, W.; Brzózka, Z.; Rudkevich, D.M.; Reinhoudt, D.N. Nitrite-Selective ISE Based on Uranyl Salophen Derivatives. *Sensor. Actuator. B. Chem.* **1996**, *37* (3), 151–155.
26. Pedersen, C.J. Cyclic Polyethers and Their Complexes with Metal Salts. *J. Am. Chem. Soc.* **1967**, *89* (26), 7017–7036.
27. Carmichael, V.E.; Dutton, P.J.; Fyles, T.M.; James, T.D.; Swan, J.A.; Zojaji, M. Biomimetic Ion Transport: A Functional Model of a Unimolecular Ion Channel. *J. Am. Chem. Soc.* **1989**, *111* (2), 767–769.

28. Fyles, T.M.; James, T.D.; Kaye, K.C. Biomimetic Ion Transport: on the Mechanizm of Ion Transport by Artificial Ion Channel Mimic. *Can. J. Chem.* **1990**, *68* (2), 976–978.
29. Fyles, T.M. Principles of Artificial Membrane Transport of Ions by Synthetic Ionophores. In *Inclusion Aspects of Membrane Chemistry*; Osa, T., Atwood, J.L., Eds.; Kluwer Academic Publishers: Dordrecht, 1991; 59–110.
30. Dulyea, L.M.; Fyles, T.M.; Robertson, G.D. Couplet Transport Membranes Incorporating a Polymeric Crown Ether Carboxylic Acid. *J. Membr. Sci.* **1987**, *34* (1), 87–108.
31. Tunca, U. Synthesis of Polymers Containing Crown Ether and Ferrocene Units. *Polymer* **1996**, *73* (17), 3997–3999.
32. Tien, H.T. Antibiotics and Ion Permeability of BLM. In *Bilayer Lipid Membranes (BLM) Theory and Practice*, 1st Ed.; Marcel Dekker, Inc.: New York, 1974, 189–216.
33. Eisenman, G.; Horn, R. Ionic Selectivity Revisited: the Role of Kinetic and Aquilibrium Processes in Ion Permeation Through Channels. *J. Membr. Biol.* **1983**, *76* (3), 197–225.
34. De Levie, R. Electrochemical Response of Porous and Rough Electrodes. In *Advances in Electrochemistry and Electrochemical Engineering*. Delahay, P., Ed.; John Wiley & Sons: New York, 1967; 329–399.
35. Aranda, P.; Galvan, J.C.; Casal, B.; Ruizhitzky, E. Electrochemical Characterization of Composite Membranes Based on Crown-ethers Intercalated Into Montmorillonite. *Colloid Polym. Sci.* **1994**, *272*, 712–720.
36. Kontturi, K.; Murtomaki, L. Impedance of a Porous Ion Exchange Membrane. *Mod. Chem.* **1995**, *132* (1), 1–16.
37. Slauyters-Rehbach, M. Impedances of Electrochemical Systems: Terminology, Nomenclature And Representation. *Pure Appl. Chem.* **1994**, *66* (9), 1831–1891.
38. Kontturi, K.; Murtomaki, L. Impedance Spectroscopy in Human Skin: A Refined Model. *Pharmaceut. Res.* **1994**, *11* (9), 1355–1357.
39. Nishikata, A.; Ichihara, Y.; Tsuru, T. An Application of Electrochemical Impedance Spectroscopy to Atmospheric Corrosion Study. *Corros. Sci.* **1995**, *37* (6), 897–911.
40. Wang, H.; Sun, L.; Armstrong, R.D. Measurements of Diffusion Coefficients of the Neutral Ionophores in Plasticized PVC Membranes Using Small Amplitude ac/dc Techniques. *Electrochim. Acta* **1996**, *41* (9), 1491–1493.
41. Zaluski, C.S.; Xu, G. AC Impedance and Conductivity Study of Alkali Salt Form Perfluorosulfonate Ionomer Membranes. *J. Electrochem. Soc.* **1994**, *141* (2), 448–450.
42. Canet, L.; Vanel, P.; Aouad, N.; Tronel-Peyroz, E.; Palmeri, J.; Seta, P. Impedance and Electrical Potential Across Supported Liquid Membranes: Role of Interfacial Potentials on the Active Transport of a Metal Cation. *J. Membr. Sci.* **1999**, *163* (1), 109–121.
43. Molisak-Tolwinska, H.; Wencel, A.; Figaszewski, Z. The Effect of Hydrophilization of Polypropylene Membranes with Alcohols on Their Transport Properties. *J. Macromol. Sci.—Pure Appl. Chem.* **1998**, *A35* (5), 857–865.
44. Molisak-Tolwinska, H.; Wencel, A.; Figaszewski, Z. Impedance of Polypropylene Membranes Hydrophilized with Ethyl Alcohol. *J. Macromol. Sci.—Pure Appl. Chem.* **1997**, *A34* (8), 1413–1427.



45. Falkiewicz, D.; Figaszewski, Z.; Molisak-Tolwinska, H. Application of Chronoamperometry to Evaluation of Membrane Porosity. *J. Macromol. Sci.—Pure Appl. Chem.* **1994**, *A31* (9), 1271–1288.
46. Weber, E.; Vogtle, F. Crown-Type Compounds—An Introductory Overview. In *Host Guest Complex Chemistry I*, 1st Ed.; Akademie-Verlag: Berlin, 1982, 20.
47. Boukamp, B.A. *Equivalent Circuit (Equivcrt. Pas)*, 2nd Ed.; University of Twente, 1988; 53.
48. Gajewska, I.; Pietras, S.; Rudzinska, J.; Schellenberg, A., Eds. *Engineers Handbook*, 2nd Ed.; WNT: Warszawa, 1974; Vol. 2, 337.
49. Thunhorst, K.L.; Noble, R.D.; Bowman, C.N. Properties of the Transport of Alkali Salts Through Polymeric Membranes Containing Benzo-18-Crown-6 Crown Ether Functional Groups. *J. Membr. Sci.* **1999**, *156* (2), 293–302.
50. Schow, A.J.; Peterson, R.T.; Lamb, J.D. Polymer Inclusion Membranes Containing Macrocyclic Carriers for Use in Cation Separations. *J. Membr. Sci.* **1996**, *111* (2), 291–295.
51. Ion, A.C.; Moutet, J.-C.; Pailleret, A.; Popescu, A.; Saint-Aman, E.; Siebert, E.; Ungureanu, E.M. Electrochemical Recognition of Metal Cations by Poly(crown ether ferrocene) Films Investigated by Cyclic Voltammetry and Electrochemical Impedance Spectroscopy. *J. Electroanal. Chem.* **1999**, *464* (1), 24–30.
52. Ion, A.; Ion, I.; Moutet, J.-C.; Pailleret, A.; Popescu, A.; Saint-Aman, E.; Ungureanu, E.; Siebert, E.; Ziessel, R. Electrochemical Recognition of Metal Cations by Redox-Active Receptors in Homogeneous Solution and in Polymer Films: Some Relevant Examples. *Sens. Actuators, B Chem.* **1999**, *59* (2–3), 118–122.

Received May 12, 2000

Revision received October 1, 2000